

Data structures for 3D Meshes

Paolo Cignoni

paolo.cignoni@isti.cnr.it

<http://vcg.isti.cnr.it/~cignoni>

Surfaces

- ❖ A 2-dimensional region of 3D space
- ❖ *A portion of space having length and breadth but no thickness*

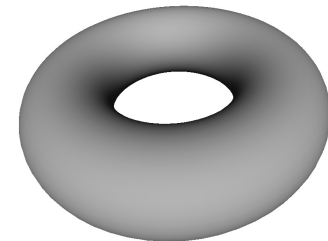
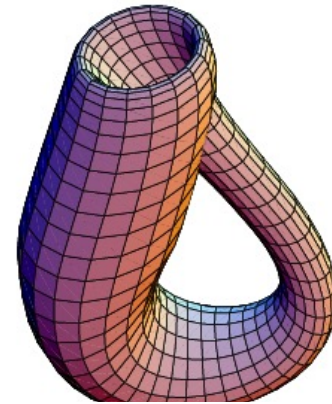
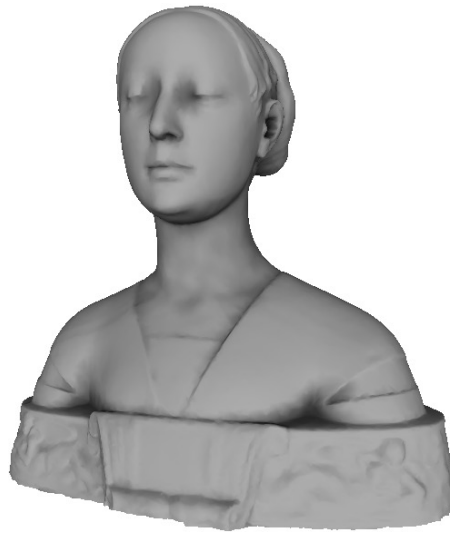
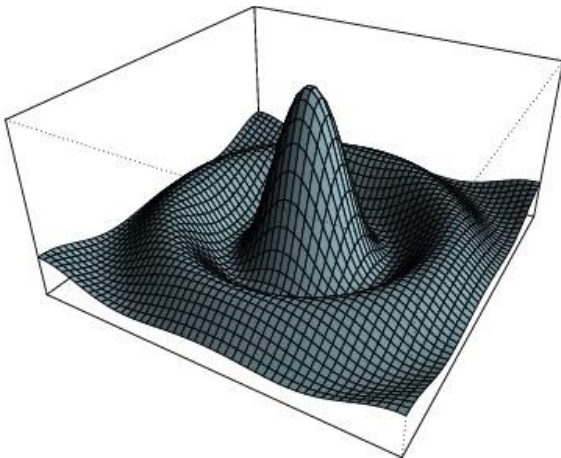

Defining Surfaces

❖ Analytic definitions

(aka exact)

❖ **Parametric surfaces**

A function that maps points on a 2D domain over a 3D surface

$$S: \mathbb{R}^2 \rightarrow \mathbb{R}^3$$

❖ **Implicit surfaces**

A surface defined where the points of the 3D space satisfy a certain property (usually a given function = 0)

$$S = \{p \in \mathbb{R}^3 : f(p) = 0\}$$

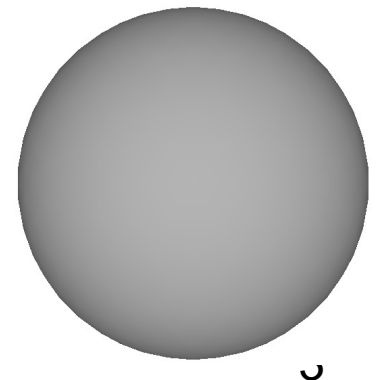
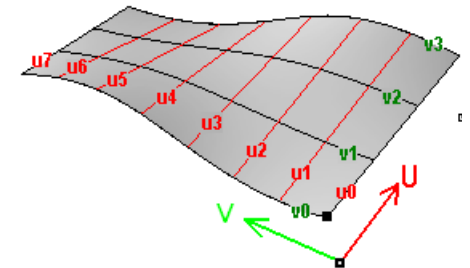
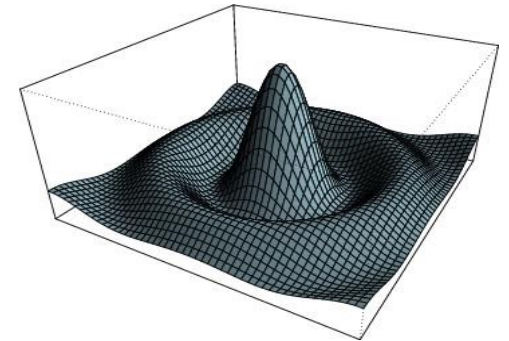

Analytic Surfaces

❖ Parametric surfaces

A function that maps points on a 2D domain over a 3D surface:

$$S: \mathbb{R}^2 \rightarrow \mathbb{R}^3$$

$$S(x, y) = \left(x, y, \sin\left(\sqrt{x^2 + y^2}\right) / \sqrt{x^2 + y^2} \right)$$

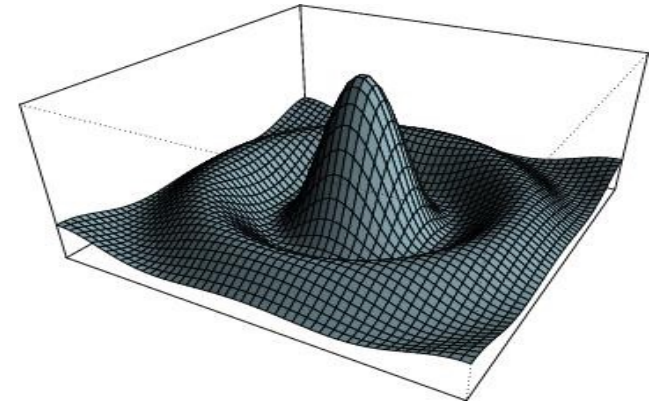

$$x = (R + r \cdot \sin t) \cdot \cos s$$

$$y = (R + r \sin t) \cdot \sin s$$

$$z = r \cdot \cos t$$

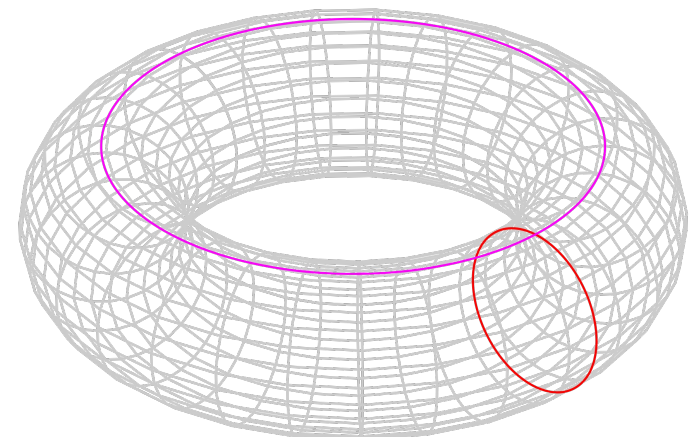

Analytic Surfaces

❖ Implicit surfaces

A surface defined where the points of the 3D space satisfy a certain property (usually a given function = 0)

$$S = \{p \in \mathbb{R}^3 : f(p) = 0\}$$

$$S = \{(x, y, z) : x^2 + y^2 + z^2 - r^2 = 0\}$$

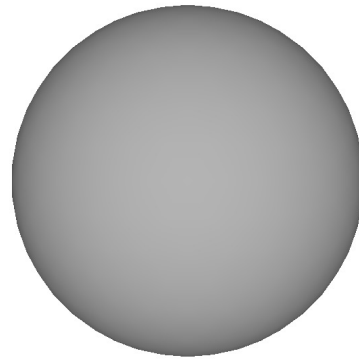

$$S = \{(x, y, z) : (x^2 + y^2 + R^2 - r^2)^2 - 4R^2(x^2 + y^2) = 0\}$$

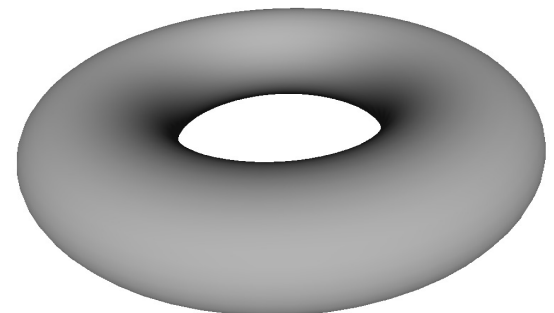

Representing Real World Surfaces

- ❖ Analytic definition falls short of representing *real world* surfaces in a *tractable* way

$$S(x, y) = \dots ?$$

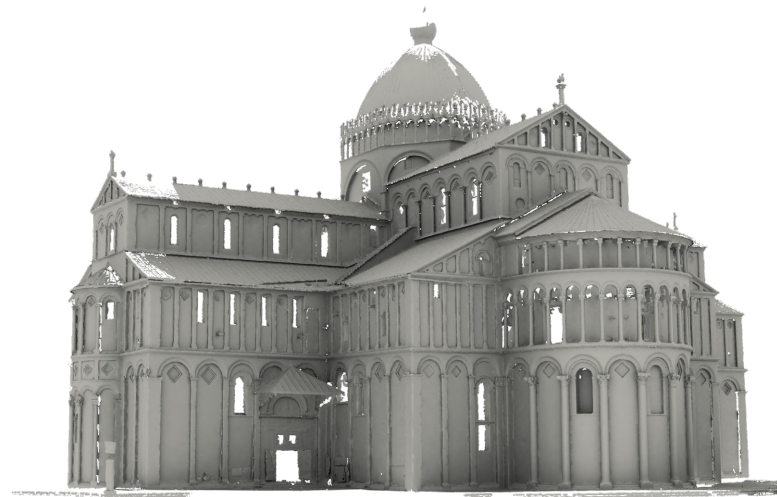

... surfaces can be represented by **cell complexes**

Cell complexes (meshes)

❖ Intuitive description: a continuous surface divided in polygons

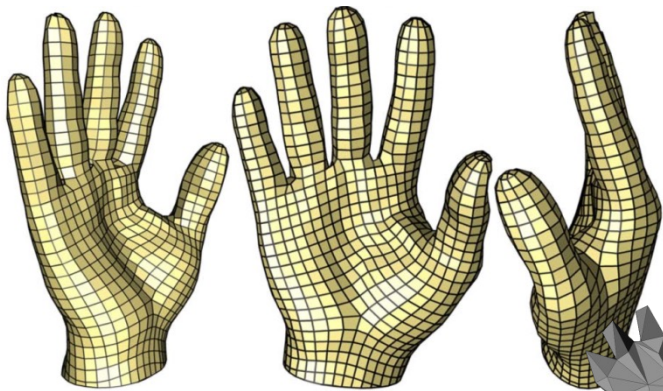

quadrilaterals (quads)

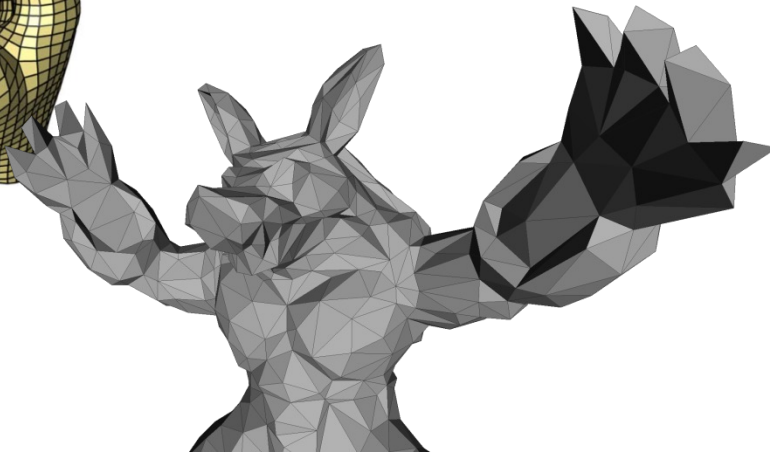

triangles

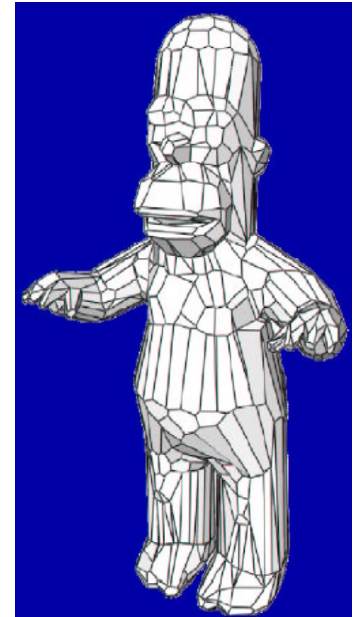

Generic polygons

Cell Complexes (meshes)

❖ In nature, meshes arise in a variety of contexts:

❖ Cells in organic tissues

❖ Crystals

❖ Molecules

❖ ...

❖ Mostly *convex* but *irregular* cells

❖ Common concept: *complex* shapes can be described as *collections of simple building blocks*

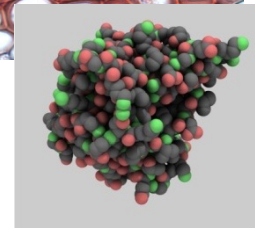
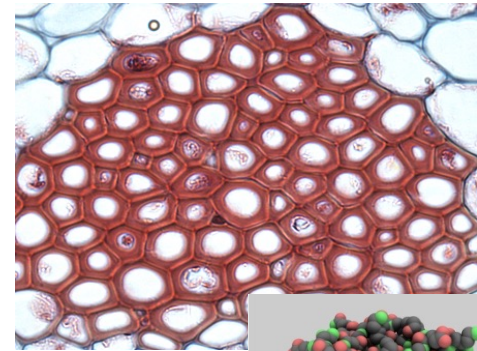
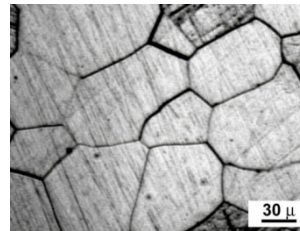

Cell Complexes (meshes)

- ❖ Slightly more formal definition
 - ❖ a *cell* is a convex polytope in
 - ❖ a *proper face* of a cell is a lower dimension convex polytope subset of a cell

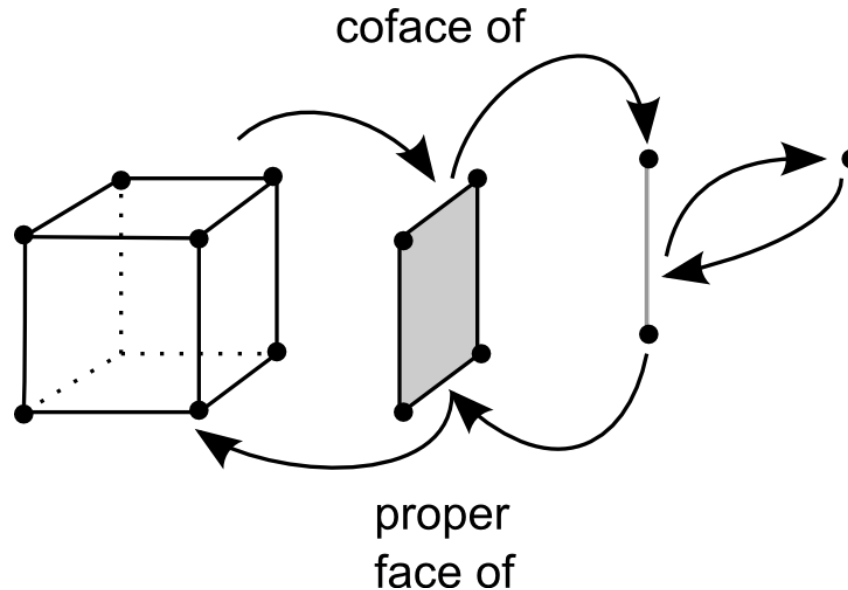

Cell Complexes (meshes)

- ❖ a collection of cells is a complex **iff**
 - ❖ every face of a cell belongs to the complex
 - ❖ For every cells C and C' , their intersection either is empty or is a common face of both

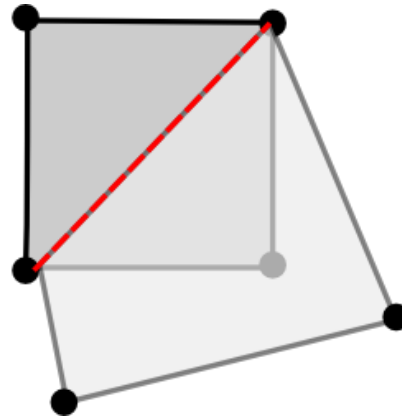
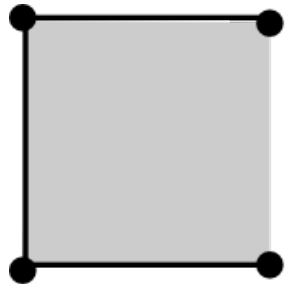

Maximal Cell Complex

- ❖ the **order** of a cell is the number of its sides (or vertices)
- ❖ a complex is a **k-complex** if the maximum of the order of its cells is k
- ❖ a cell is **maximal** if it is not a face of another cell
- ❖ a k-complex is **maximal** *iff* all maximal cells have order k
- ❖ short form : no dangling edges!

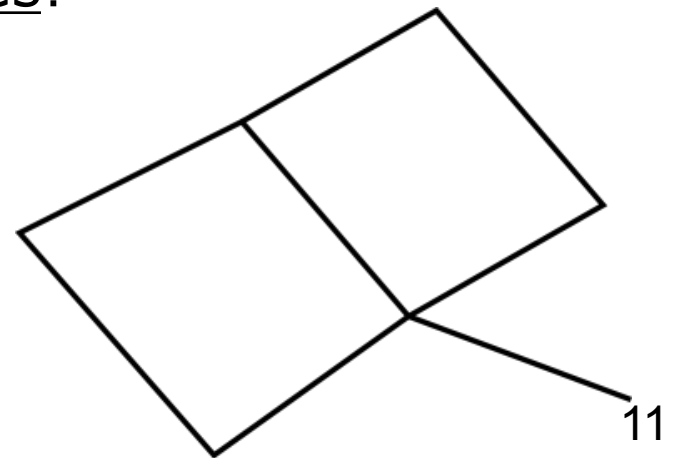

Simplicial Complex

- ❖ A cell complex is a **simplicial complex** when the cells are simplexes
- ❖ A ***d-simplex*** is the convex hull of $d+1$ points in



0-simplex

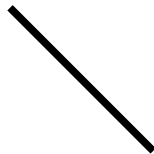

1-simplex

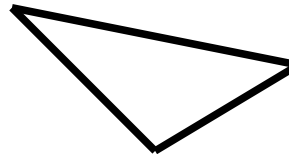

2-simplex

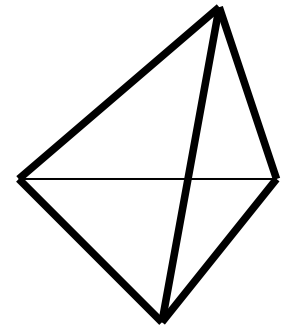

3-simplex

Sub-simplex / face

- ❖ A simplex σ' is called *face* of another simplex σ if it is defined by a subset of the vertices of σ
- ❖
- ❖ If $\sigma \neq \sigma'$ it is a proper face

Simplicial Complex

- ❖ A collection of simplexes Σ is a simplicial k -complex iff:
 - ❖ $\forall \sigma_1, \sigma_2 \in \Sigma$
 $\sigma_1 \cap \sigma_2 \neq \emptyset \Rightarrow \sigma_1 \cap \sigma_2$ is a simplex of Σ
 - ❖ $\forall \sigma \in \Sigma$ all the faces of σ belong to Σ
 - ❖ k is the maximum degree of simplexes in Σ

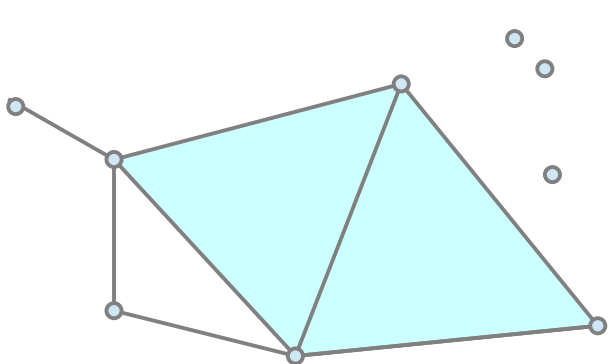

OK

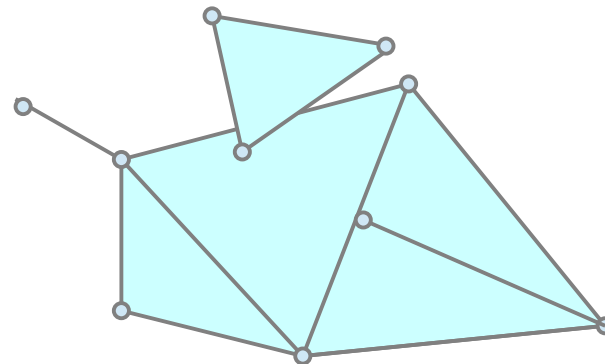

Not Ok

Simplicial Complex

- ❖ A simplex σ is maximal in a simplicial complex Σ if it is not a proper face of a another simplex σ' of $\text{di } \Sigma$
- ❖ A simplicial k -complex Σ is maximal if all its maximal simplex are of order k
 - ❖ No dangling lower dimensional pieces

Non maximal 2-simplicial complex

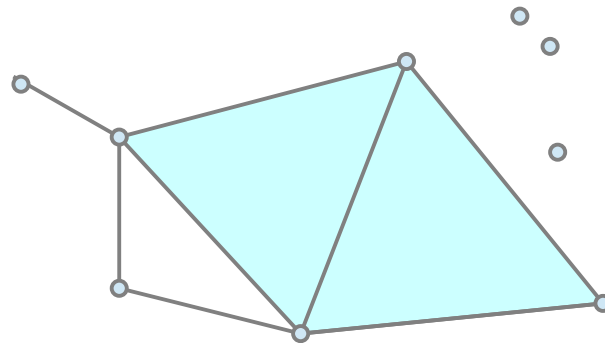

Meshes, at last

- ❖ When talking of *triangle mesh* the intended meaning is a **maximal 2-simplicial complex**

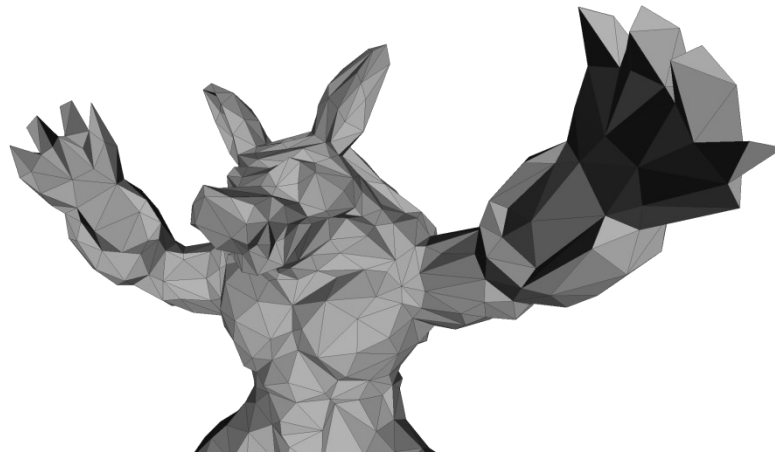

Topology vs Geometry

- ❖ It is quite useful to discriminate between:
 - ❖ Geometric realization
 - ❖ **Where** the vertices are actually placed in space
 - ❖ Topological Characterization
 - ❖ **How** the elements are combinatorially connected

Topology vs geometry 2

Given a certain shape we can represent it in many different ways; topologically different but quite similar from a geometric point of view (demo klein bottle)

- ❖ Note that we can say many things on a given shape just by looking at its topology:
 - ❖ Manifoldness
 - ❖ Borders
 - ❖ Connected components
 - ❖ Orientability

Manifoldness

- ❖ a surface S is **2-manifold** *iff*:
 - ❖ the neighborhood of each point is homeomorphic to Euclidean space in two dimension
or ... in other words..
 - ❖ the neighborhood of each point is homeomorphic to a disk (or a semidisk if the surface has boundary)

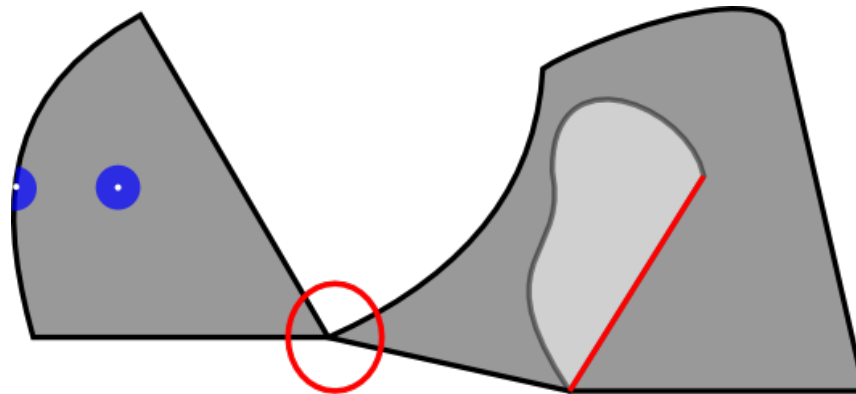

Orientability

- ❖ A surface is **orientable** if it is possible to make a consistent choice for the normal vector
 - ❖ ...it has two sides
- ❖ Moebius strips, klein bottles, and non manifold surfaces are not orientable

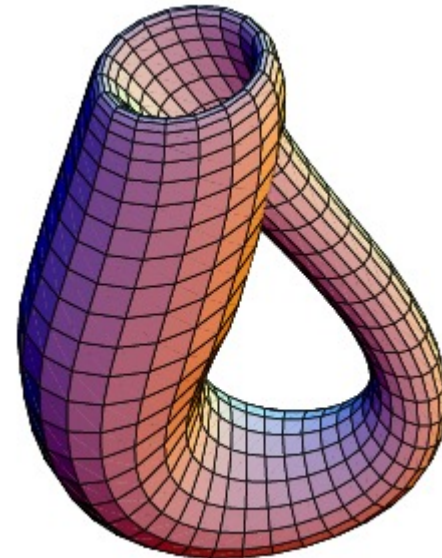
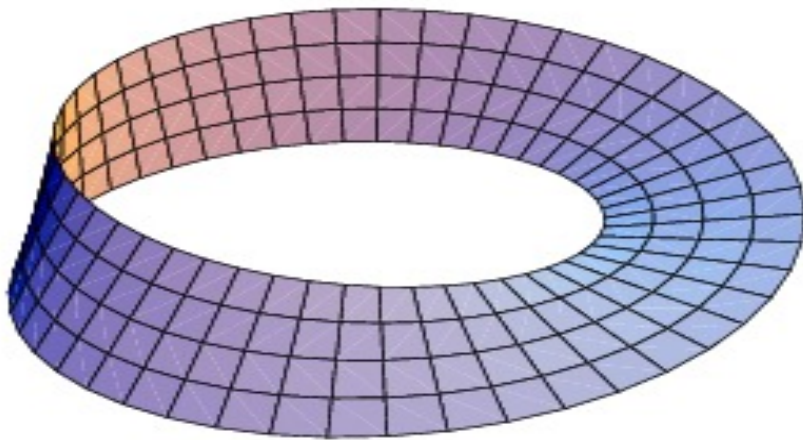

Adjacency/Incidency

- ❖ Two simplexes σ e σ' are **incident** if σ is a proper face of σ' (or viceversa)
- ❖ Two k -simplexes σ e σ' s are **m -adjacent** ($k > m$) if there exists a m -simplex that is a proper face of σ e σ'
 - ❖ Two triangles sharing an edge are 1-adjacent
 - ❖ Two triangles sharing a vertex are 0-adjacent

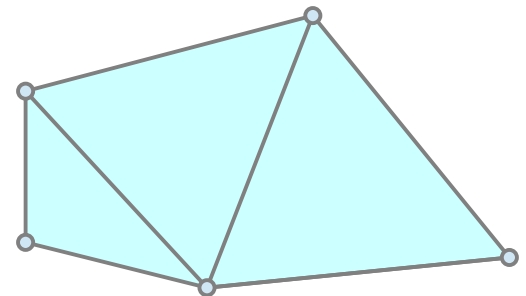

Adjacency Relations

- ❖ An intuitive convention to name practically useful topological relations is to use an *ordered* pair of letters denoting the involved entities:
 - ❖ **FF** edge adjacency between triangular **F**aces
 - ❖ **FV** from **F**aces to **V**ertices (e.g. the vertices composing a face)
 - ❖ **VF** from a **V**ertex to a triangle (e.g. the triangles incident on a vertex)

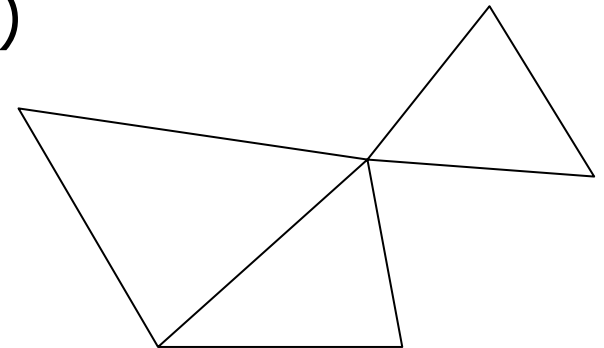

Adjacency Relationship

- ❖ Usually we only keep a small subset of all the possible adjacency relationships
- ❖ The other ones are procedurally generated

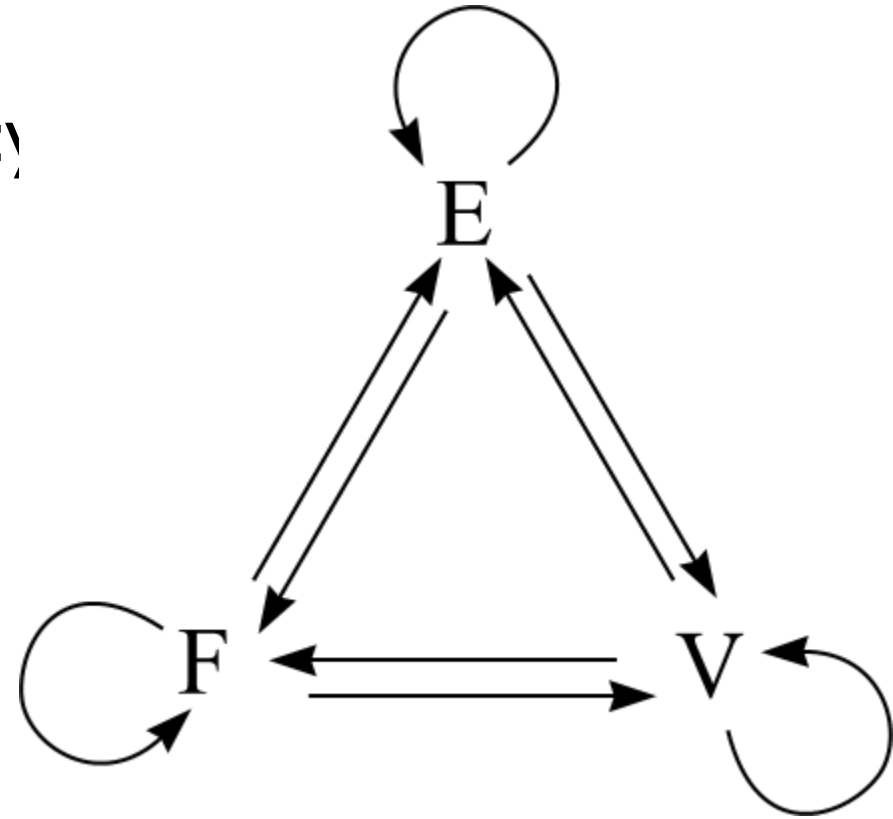

Adjacency Relation

- ❖ $FF \sim 1$ -adjacency
- ❖ $EE \sim 0$ adjacency
- ❖ $FE \sim$ proper subspace of F with $\dim 1$
- ❖ $FV \sim$ proper subspace of F con $\dim 0$
- ❖ $EV \sim$ proper subspace of E con $\dim 0$
- ❖ $VF \sim F$ in Σ : V proper subspace of F
- ❖ $VE \sim E$ in Σ : V proper subspace of E
- ❖ $EF \sim F$ in Σ : E proper subspace of F
- ❖ $VV \sim V'$ in Σ : it exists an edge $E:(V,V')$

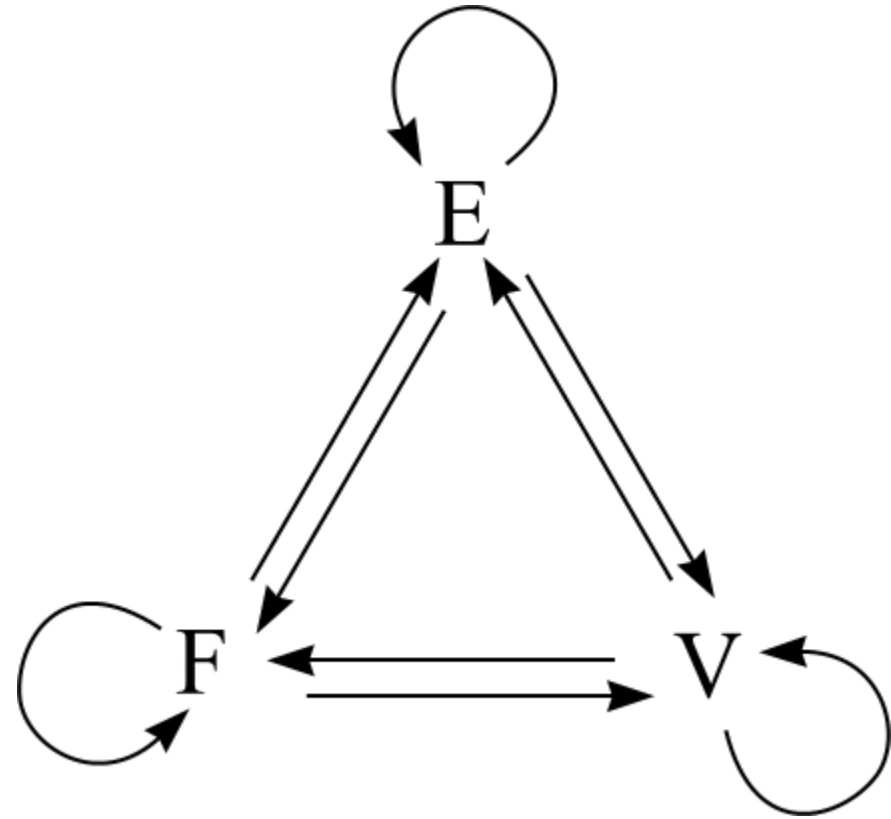

Partial adjacency

- ❖ For sake of conciseness it can be useful to keep only a partial information
 - ❖ VF^* memorize only a reference from a vertex to a face and then surf over the surface using FF to find the other faces incident on V

Adjacency Relation

- ❖ For a two manifoldsimplicial 2-complex in R^3
 - ❖ FV FE FF EF EV have bounded degree (are constant if there are no borders)
 - ❖ $|FV| = 3$ $|EV| = 2$ $|FE| = 3$
 - ❖ $|FF| \leq 2$
 - ❖ $|EF| \leq 2$
 - ❖ VV VE VF EE have variable degree but we have some avg. estimations:
 - ❖ $|VV| \sim |VE| \sim |VF| \sim 6$
 - ❖ $|EE| \sim 10$
 - ❖ $F \sim 2V$

Euler characteristic



$$\chi = V - E + F$$

V : number of vertices

E : number of edges

F : number of faces

The Five Platonic Solids

Tetrahedron



Hexahedron or cube

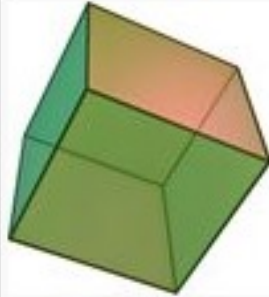

Octahedron







Dodecahedron



Icosahedron

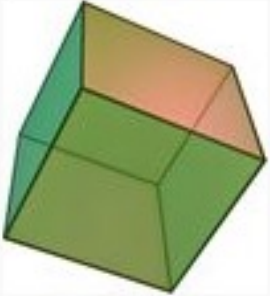

The Five Platonic Solids

<u>Tetrahedron</u>		4	6	4
<u>Hexahedron</u> or <u>cube</u>		8	12	6
<u>Octahedron</u>		6	12	8
<u>Dodecahedron</u>		20	30	12
<u>Icosahedron</u>		12	30	20

Euler characteristics

- ❖ $\chi = 2$ for any *simply connected* polyhedron
- ❖ proof by construction...
- ❖ play with examples:

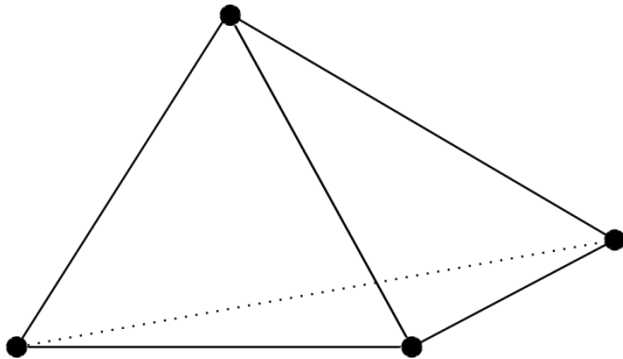

$$\begin{aligned}\chi &= V - E + F \\ \chi &= 4 - 6 + 4 = 2\end{aligned}$$

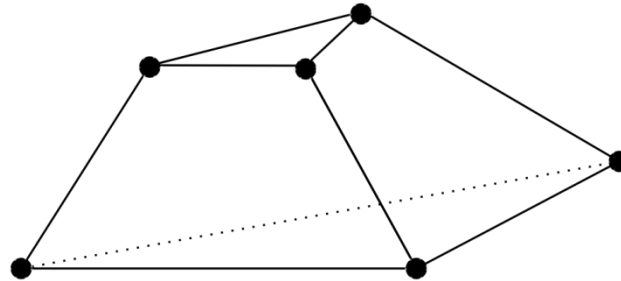

$$\begin{aligned}\chi &= (V + 2) - (E + 3) + (F + 1) = \\ \chi &= (4 + 2) - (6 + 3) + (4 + 1) = 2\end{aligned}$$

Euler characteristics

❖ let's try a more complex figure...

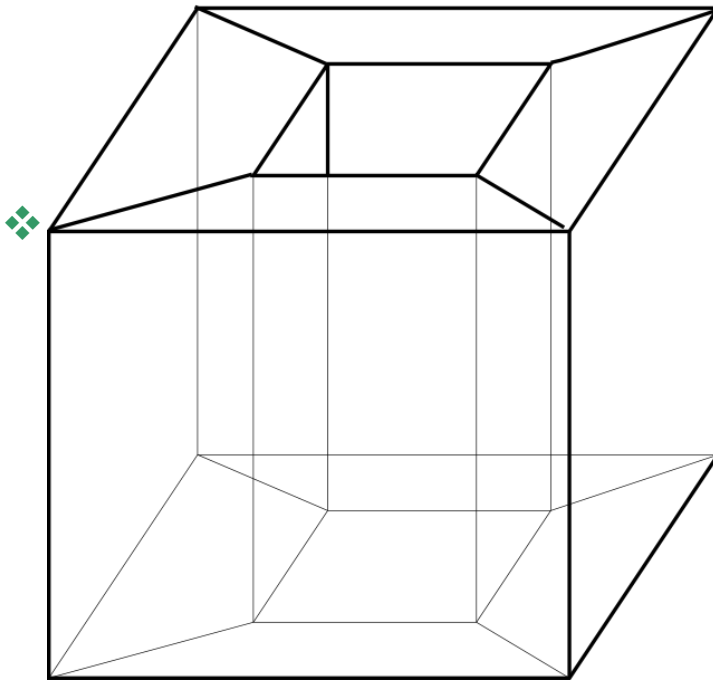

$$\chi = V - E + F$$
$$\chi = 16 - 32 + 16 = 0$$

❖ why = 0 ?

Genus

❖ The **Genus** of a closed surface, orientable and 2-manifold is the maximum number of cuts we can make along non intersecting closed curves without splitting the surface in two.

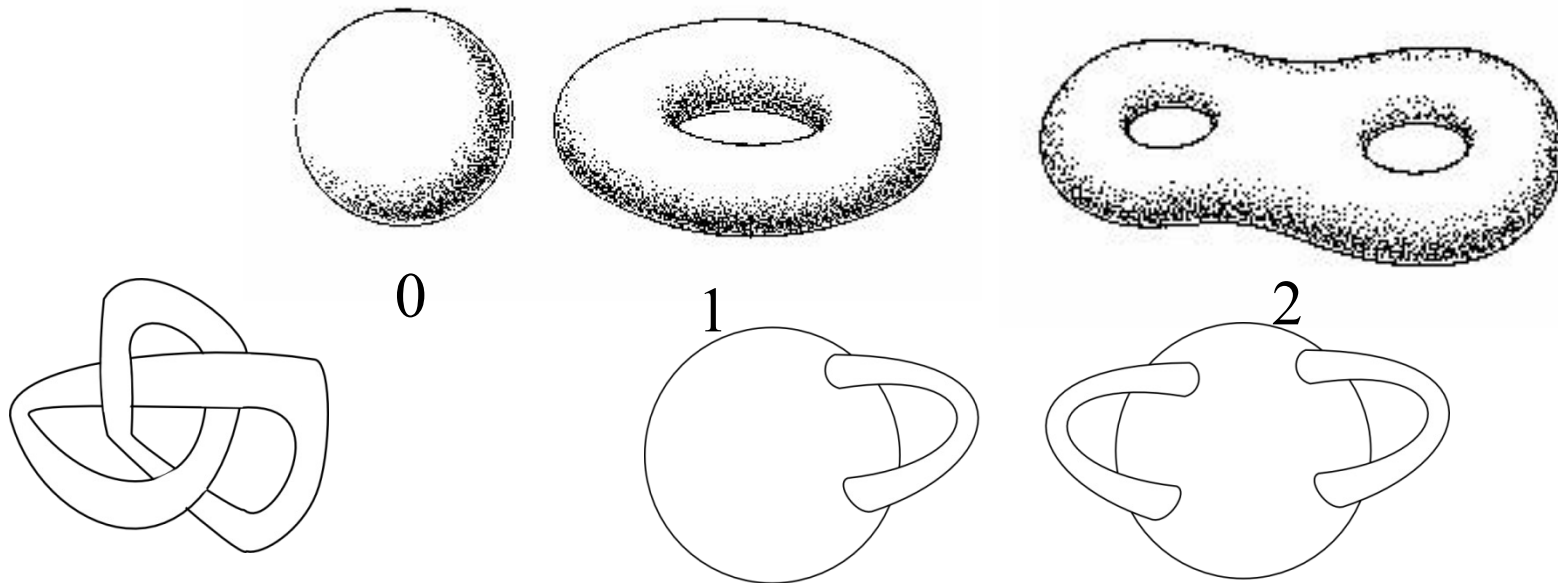

❖ ...also known as the number of *handles*

Genus

*To a topologist, a coffee **cup** and a **donut** are the same thing*





Euler characteristics

$$\chi = 2 - 2g$$

❖ where g is the genus of the surface

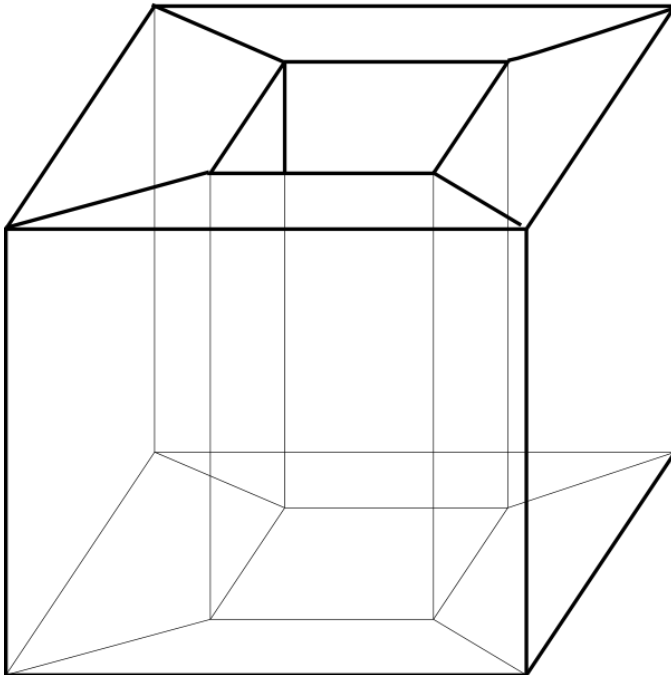

$$\begin{aligned}\chi &= V - E + F \\ \chi &= 16 - 32 + 16 = 0 = 2 - 2g\end{aligned}$$

Euler characteristics

- ❖ let's try a more complex figure...remove a face. The surface is not closed anymore

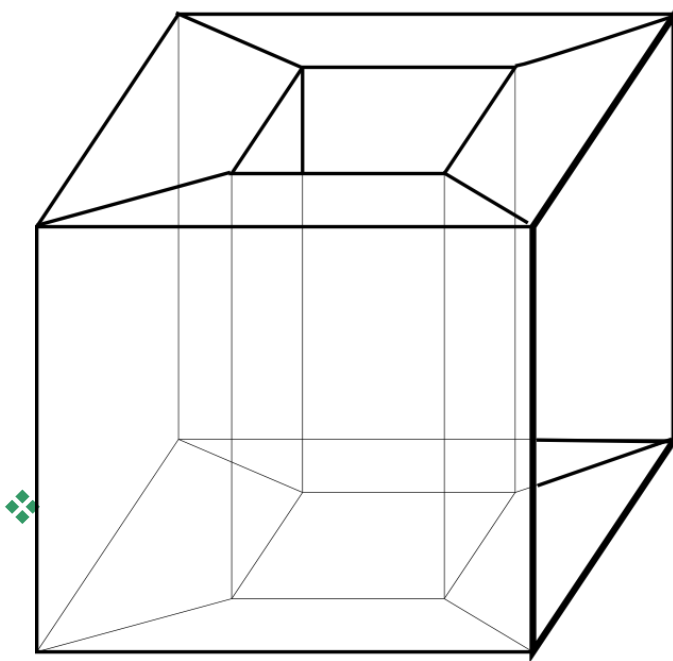

$$\chi = V - E + F$$
$$\chi = 16 - 32 + 15 = -1$$

- ❖ why = -1 ?

Euler characteristics

$$\chi = 2 - 2g - b$$

- ❖ where b is the number of borders of the surface

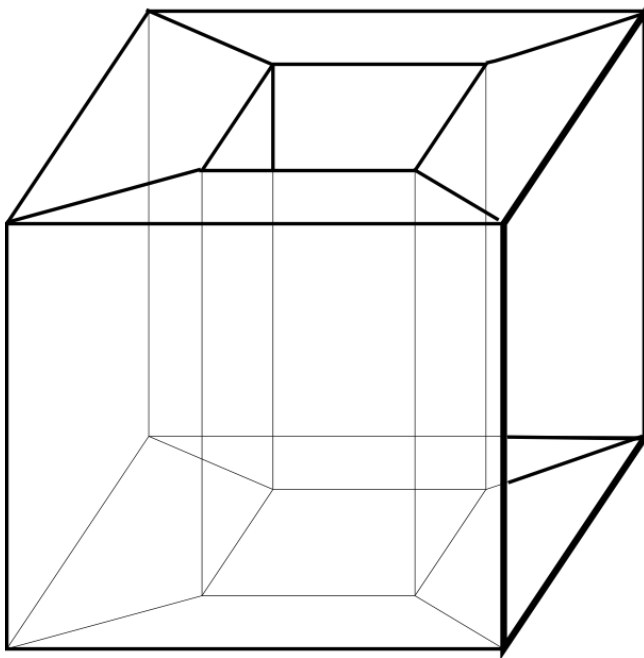

$$\begin{aligned}\chi &= V - E + F \\ \chi &= 16 - 32 + 15 = -1 = 2 - 2g - b\end{aligned}$$

Euler characteristics

- ❖ *Remove the border by adding a new vertex and connecting all the k vertices on the border to it.*

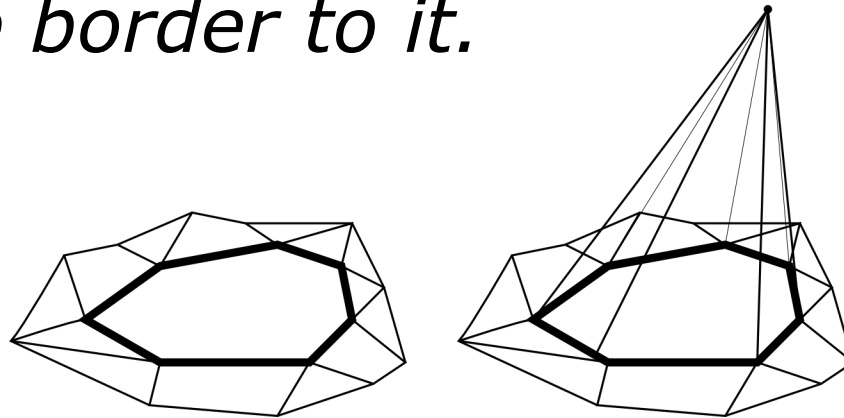

A

A'

$$X' = X + V' - E' + F' = X + 1 - k + k = X + 1$$

Converting Representations

Parametric Surface to Mesh

- ❖ *Easy. Just Sample the function on a regular domain and build a grid*
- ❖ *Issues*
- ❖ *Regular sampling does not imply regular meshing*

Converting Representations

Implicit Representation to Mesh

$$S = \{p \in \mathbb{R}^3 : f(p) = 0\} \quad S = \{p \in \mathbb{R}^3 : f(p) = 0\}$$

Isosurface on a regular grid

- ❖ *Sample the function on a regular grid and apply marching cube algorithm*

Converting Representations

Implicit Representation to Mesh *Marching Cube*

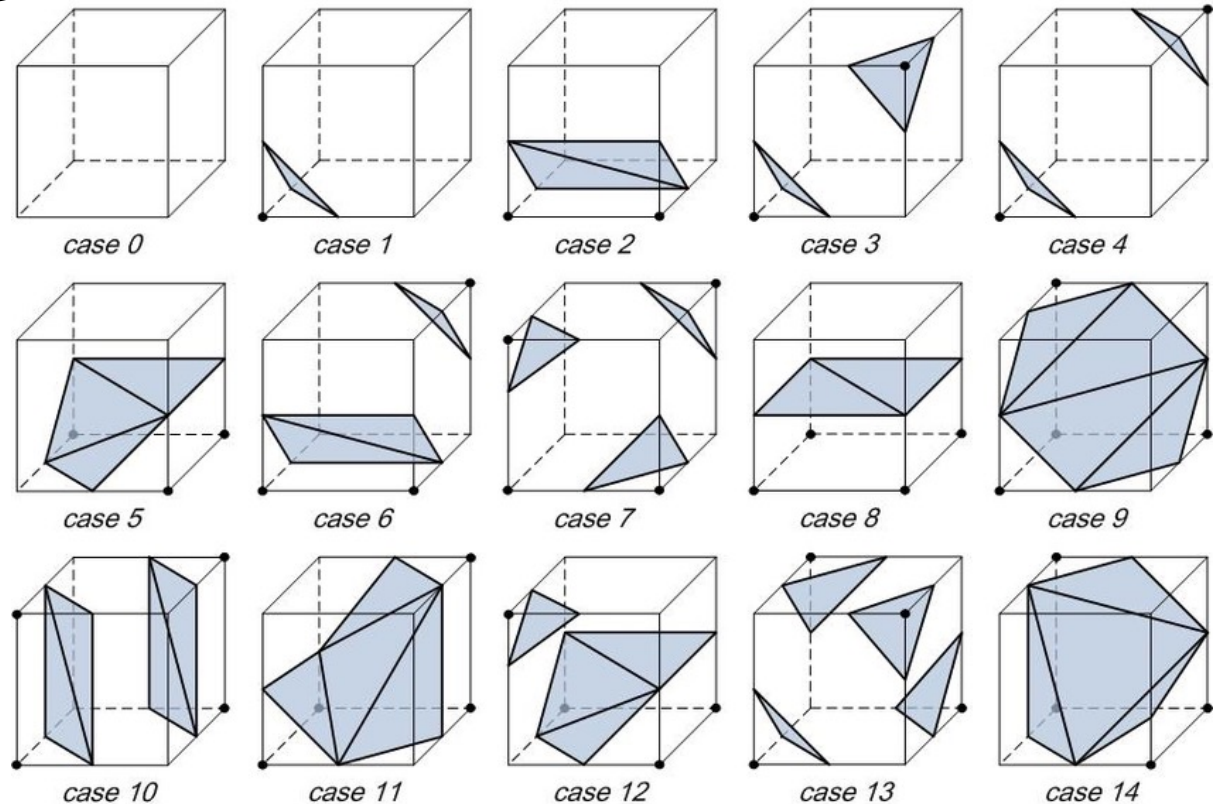

Converting Representations

Mesh to Implicit Representation

Regularly Sampled Distance Field

For each point on a grid
store the signed distance
from the surface

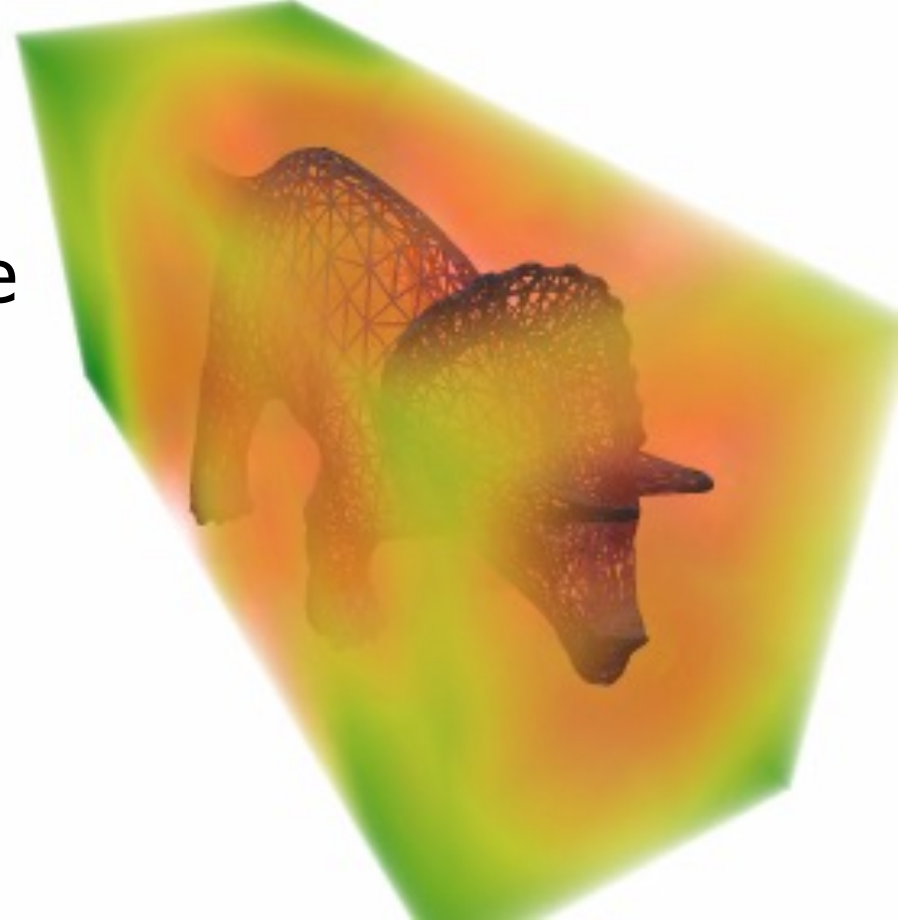

Converting Representations

Implicit Representation \leftrightarrow Mesh

Issues:

❖ *Sampling Artifacts*

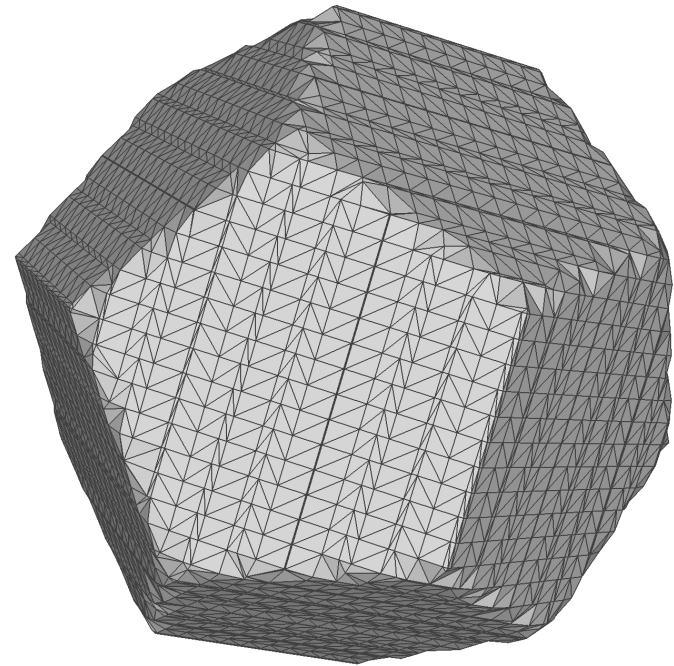
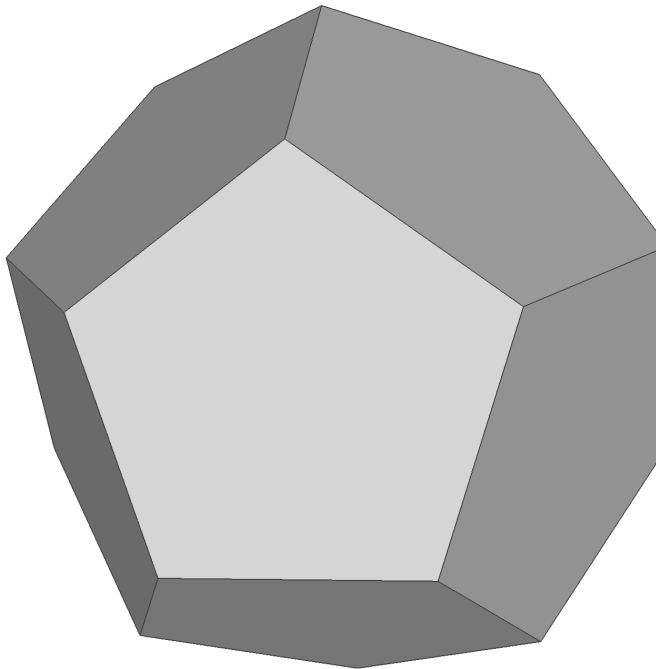

Mesh Data structures

- ❖ How to store geometry & connectivity?
 - ❖ compact storage
 - ❖ file formats
 - ❖ efficient algorithms on meshes
 - ❖ identify time-critical operations
 - ❖ all vertices/edges of a face
 - ❖ all incident vertices/edges/faces of a vertex

Face Set (STL)

- face:
 - 3 positions

Triangles		
X ₁₁ Y ₁₁ Z ₁₁	X ₁₂ Y ₁₂ Z ₁₂	X ₁₃ Y ₁₃ Z ₁₃
X ₂₁ Y ₂₁ Z ₂₁	X ₂₂ Y ₂₂ Z ₂₂	X ₂₃ Y ₂₃ Z ₂₃
...
X _{F1} Y _{F1} Z _{F1}	X _{F2} Y _{F2} Z _{F2}	X _{F3} Y _{F3} Z _{F3}

36 B/f = 72 B/v
no connectivity!

Typical Mesh Operation

- Access to individual vertices, edges, and faces. (enumeration of all elements in unspecified order)
- Oriented traversal of the edges of a face, which refers to finding the next edge (or previous edge) in a face.
- Access to the incident faces of an edge. Depending on the orientation, this is either the left or right face in the manifold case.
- Given an edge, access to its two endpoint vertices.
- Given a vertex, at least one incident face or edge must be accessible. Then for manifold meshes all other elements in the so-called one-ring neighborhood of a vertex can be enumerated (i.e., all incident faces or edges and neighboring vertices).

Shared Vertex (OBJ, OFF)

- vertex:
 - position
- face:
 - vertex indices

Vertices	Triangles
x1 y1 z1	V11 V12 V13
...	...
xv yv zv	...
	...
	...
	VF1 VF2 VF3

12 B/v + 12 B/f = 36 B/v
no neighborhood info

Face-Based Connectivity

- vertex:
 - position
 - 1 face
- face:
 - 3 vertices
 - 3 face neighbors

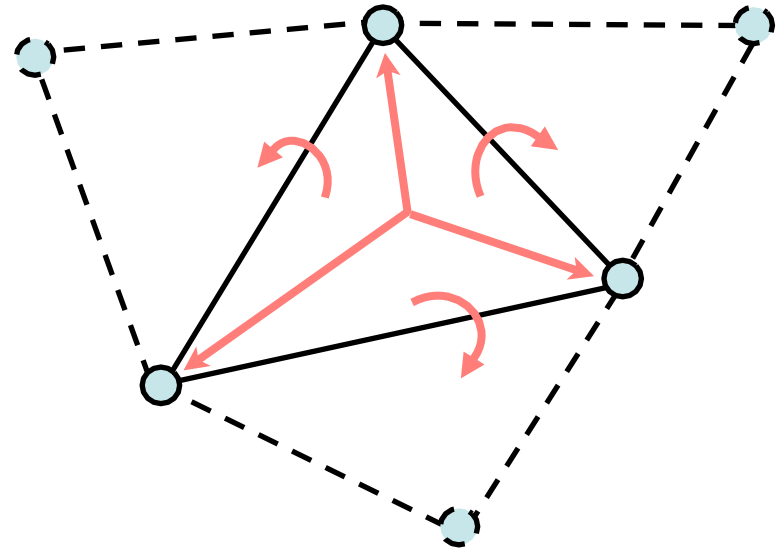

64 B/v
no edges!

Edge-Based Connectivity

- vertex
 - position
 - 1 edge
- edge
 - 2 vertices
 - 2 faces
 - 4 edges
- face
 - 1 edge

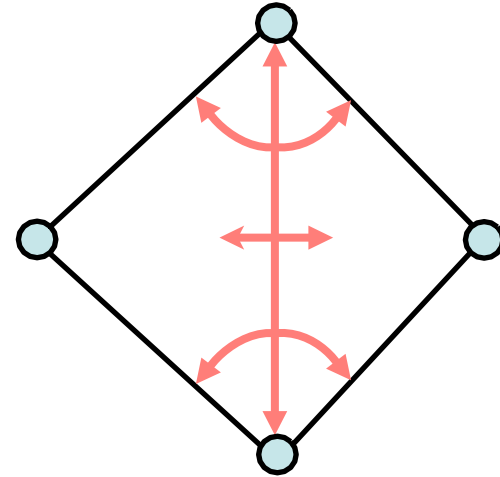

120 B/v

edge orientation?

Halfedge-Based Connectivity

- vertex
 - position
 - 1 halfedge
- halfedge
 - 1 vertex
 - 1 face
 - 1, 2, or 3 halfedges
- face
 - 1 halfedge

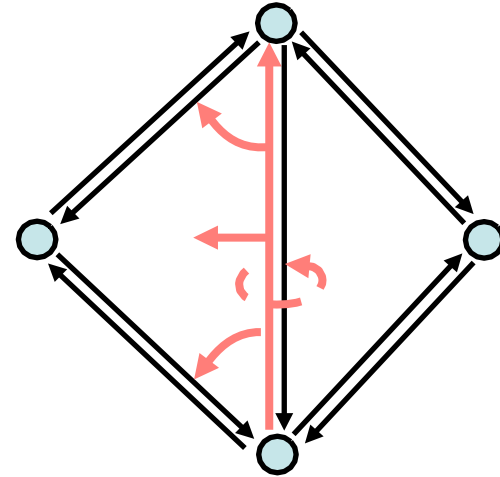

96 to 144 B/v

no case distinctions
during traversal